

**Applications**

- High frequency DC-DC converters
- Lead-Free

**Benefits**

- Low Gate-to-Drain Charge to Reduce Switching Losses
- Fully Characterized Capacitance Including Effective C<sub>OSS</sub> to Simplify Design, (See App. Note AN1001)
- Fully Characterized Avalanche Voltage and Current

<b>V<sub>DSS</sub></b>	<b>R<sub>DS(on)</sub> max</b>	<b>I<sub>D</sub></b>
<b>150V</b>	<b>0.045Ω</b>	<b>41A</b>

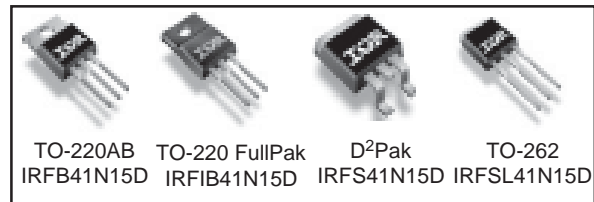

**Absolute Maximum Ratings**

	Parameter	Max.	Units
I <sub>D</sub> @ T <sub>C</sub> = 25°C	Continuous Drain Current, V <sub>GS</sub> @ 10V	41	A
I <sub>D</sub> @ T <sub>C</sub> = 100°C	Continuous Drain Current, V <sub>GS</sub> @ 10V	29	
I <sub>DM</sub>	Pulsed Drain Current ①	164	
P <sub>D</sub> @ T <sub>A</sub> = 25°C	Power Dissipation, D <sup>2</sup> Pak	3.1	W
P <sub>D</sub> @ T <sub>C</sub> = 25°C	Power Dissipation, TO-220	200	
P <sub>D</sub> @ T <sub>C</sub> = 25°C	Power Dissipation, Fullpak	48	
	Linear Derating Factor, TO-220	1.3	W/°C
	Linear Derating Factor, Fullpak	0.32	
V <sub>GS</sub>	Gate-to-Source Voltage	± 30	V
dv/dt	Peak Diode Recovery dv/dt ③	2.7	V/ns
T <sub>J</sub>	Operating Junction and	-55 to + 175	°C
T <sub>STG</sub>	Storage Temperature Range		
	Soldering Temperature, for 10 seconds		
	Mounting torque, 6-32 or M3 screw	1.1(10)	N•m (lbf•in)

**Thermal Resistance**

	Parameter	Typ.	Max.	Units
R <sub>θJC</sub>	Junction-to-Case	—	0.75	°C/W
R <sub>θJC</sub>	Junction-to-Case, Fullpak	—	3.14	
R <sub>θCS</sub>	Case-to-Sink, Flat, Greased Surface ④	0.50	—	
R <sub>θJA</sub>	Junction-to-Ambient, TO-220 ⑥	—	62	
R <sub>θJA</sub>	Junction-to-Ambient, D <sup>2</sup> Pak ⑦	—	40	
R <sub>θJA</sub>	Junction-to-Ambient, Fullpak	—	65	

Notes ① through ⑦ are on page 12

www.irf.com

# IRFB/IRFIB/IRFS/IRFSL41N15DPbF

International  
IR Rectifier

## Static @ T<sub>J</sub> = 25°C (unless otherwise specified)

	Parameter	Min.	Typ.	Max.	Units	Conditions
V <sub>(BR)DSS</sub>	Drain-to-Source Breakdown Voltage	150	—	—	V	V <sub>GS</sub> = 0V, I <sub>D</sub> = 250μA
ΔV <sub>(BR)DSS/ΔT<sub>J</sub></sub>	Breakdown Voltage Temp. Coefficient	—	0.17	—	V/°C	Reference to 25°C, I <sub>D</sub> = 1mA
R <sub>DS(on)</sub>	Static Drain-to-Source On-Resistance	—	—	0.045	Ω	V <sub>GS</sub> = 10V, I <sub>D</sub> = 25A ④
V <sub>GS(th)</sub>	Gate Threshold Voltage	3.0	—	5.5	V	V <sub>DS</sub> = V <sub>GS</sub> , I <sub>D</sub> = 250μA
I <sub>DSS</sub>	Drain-to-Source Leakage Current	—	—	25	μA	V <sub>DS</sub> = 150V, V <sub>GS</sub> = 0V
		—	—	250		V <sub>DS</sub> = 120V, V <sub>GS</sub> = 0V, T <sub>J</sub> = 150°C
I <sub>GSS</sub>	Gate-to-Source Forward Leakage	—	—	100	nA	V <sub>GS</sub> = 30V
	Gate-to-Source Reverse Leakage	—	—	-100		V <sub>GS</sub> = -30V

## Dynamic @ T<sub>J</sub> = 25°C (unless otherwise specified)

	Parameter	Min.	Typ.	Max.	Units	Conditions
g <sub>fs</sub>	Forward Transconductance	18	—	—	S	V <sub>DS</sub> = 50V, I <sub>D</sub> = 25A
Q <sub>g</sub>	Total Gate Charge	—	72	110	nC	I <sub>D</sub> = 25A V <sub>DS</sub> = 120V V <sub>GS</sub> = 10V ④
Q <sub>gs</sub>	Gate-to-Source Charge	—	21	31		
Q <sub>gd</sub>	Gate-to-Drain ("Miller") Charge	—	35	52		
t <sub>d(on)</sub>	Turn-On Delay Time	—	16	—	ns	V <sub>DD</sub> = 75V I <sub>D</sub> = 25A R <sub>G</sub> = 2.5Ω V <sub>GS</sub> = 10V ④
t <sub>r</sub>	Rise Time	—	63	—		
t <sub>d(off)</sub>	Turn-Off Delay Time	—	25	—		
t <sub>f</sub>	Fall Time	—	14	—		
C <sub>iss</sub>	Input Capacitance	—	2520	—	pF	V <sub>GS</sub> = 0V V <sub>DS</sub> = 25V f = 1.0MHz V <sub>GS</sub> = 0V, V <sub>DS</sub> = 1.0V, f = 1.0MHz V <sub>GS</sub> = 0V, V <sub>DS</sub> = 120V, f = 1.0MHz V <sub>GS</sub> = 0V, V <sub>DS</sub> = 0V to 120V ⑤
C <sub>oss</sub>	Output Capacitance	—	510	—		
C <sub>rss</sub>	Reverse Transfer Capacitance	—	110	—		
C <sub>oss</sub>	Output Capacitance	—	3090	—		
C <sub>oss</sub>	Output Capacitance	—	230	—		
C <sub>oss eff.</sub>	Effective Output Capacitance	—	250	—		

## Avalanche Characteristics

	Parameter	Typ.	Max.	Units
E <sub>AS</sub>	Single Pulse Avalanche Energy ②	—	470	mJ
I <sub>AR</sub>	Avalanche Current ①	—	25	A
E <sub>AR</sub>	Repetitive Avalanche Energy ①	—	20	mJ

## Diode Characteristics

	Parameter	Min.	Typ.	Max.	Units	Conditions
I <sub>S</sub>	Continuous Source Current (Body Diode)	—	—	41	A	MOSFET symbol showing the integral reverse p-n junction diode.
I <sub>SM</sub>	Pulsed Source Current (Body Diode) ①	—	—	164		
V <sub>SD</sub>	Diode Forward Voltage	—	—	1.3	V	T <sub>J</sub> = 25°C, I <sub>S</sub> = 25A, V <sub>GS</sub> = 0V ④
t <sub>rr</sub>	Reverse Recovery Time	—	170	260	ns	T <sub>J</sub> = 25°C, I <sub>F</sub> = 25A
Q <sub>rr</sub>	Reverse Recovery Charge	—	1.3	1.9	μC	di/dt = 100A/μs ④
t <sub>on</sub>	Forward Turn-On Time	Intrinsic turn-on time is negligible (turn-on is dominated by LS+LD)				

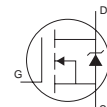

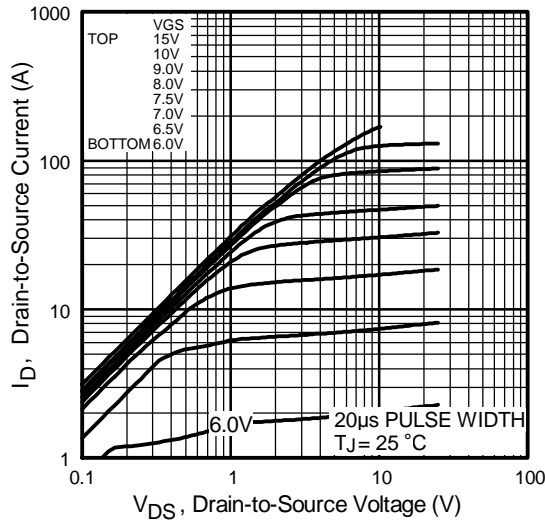

Fig 1. Typical Output Characteristics

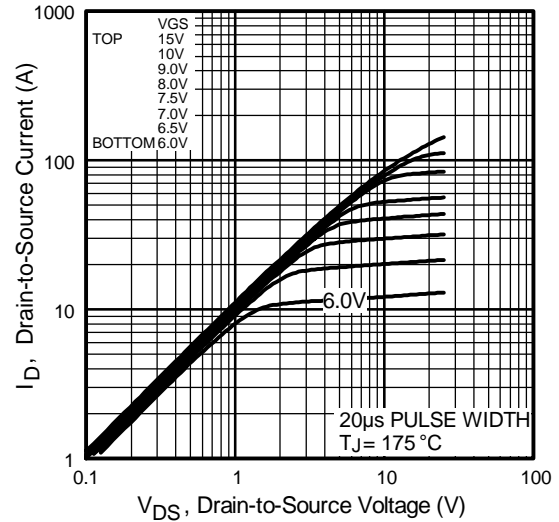

Fig 2. Typical Output Characteristics

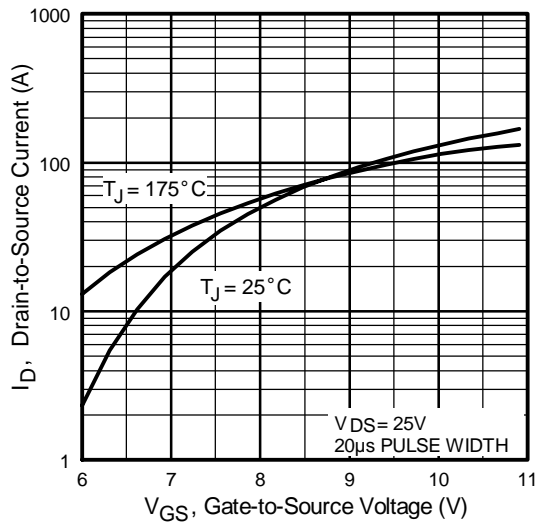

Fig 3. Typical Transfer Characteristics

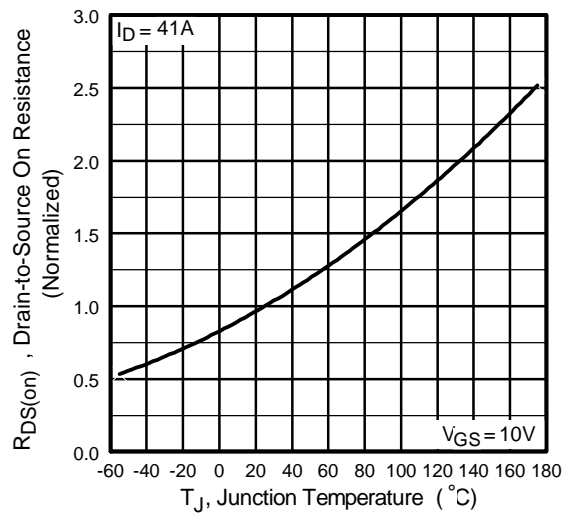
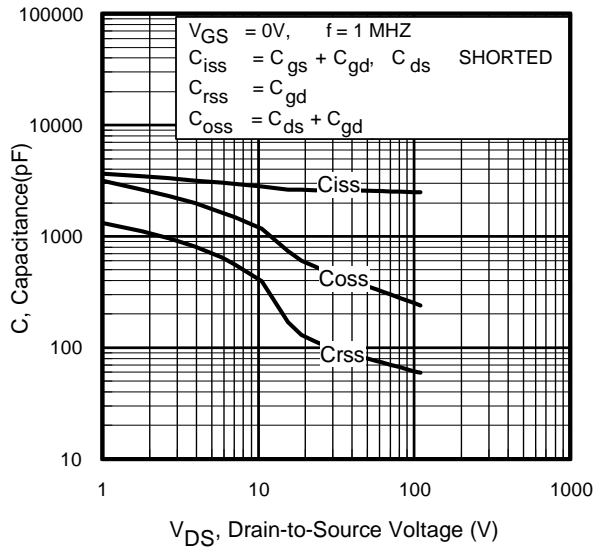
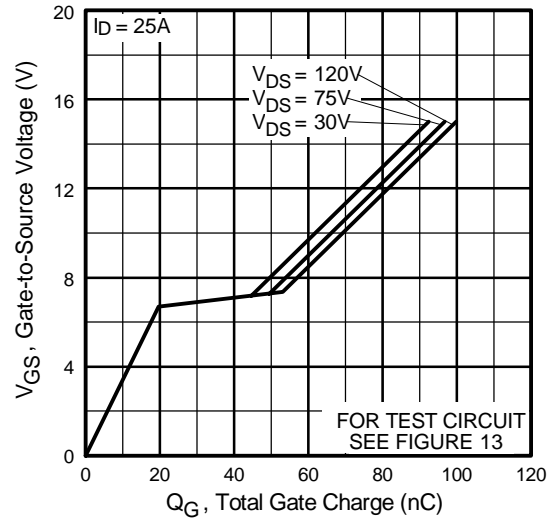

Fig 4. Normalized On-Resistance vs. Temperature



**Fig 5.** Typical Capacitance Vs. Drain-to-Source Voltage



**Fig 6.** Typical Gate Charge Vs. Gate-to-Source Voltage

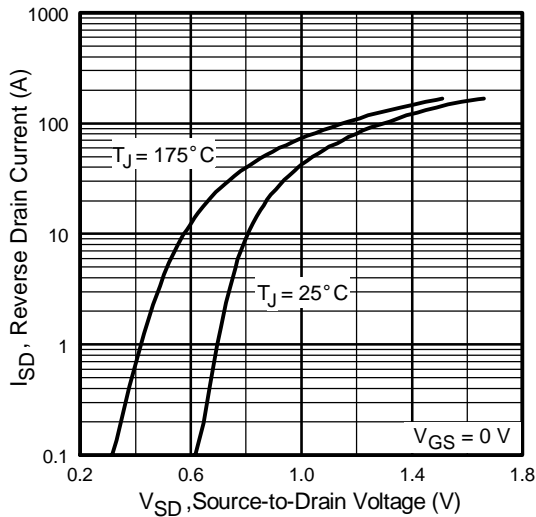

**Fig 7.** Typical Source-Drain Diode Forward Voltage

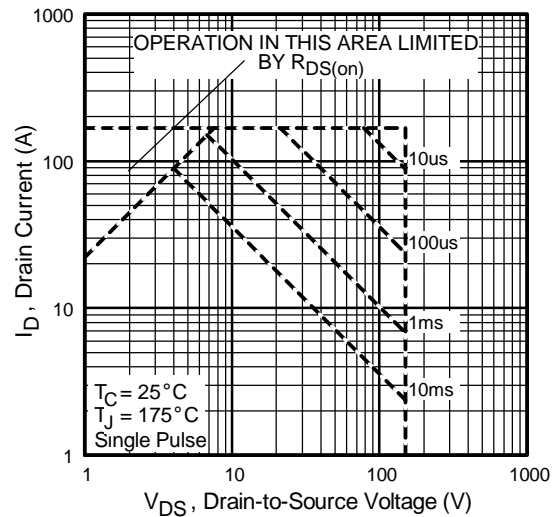

**Fig 8.** Maximum Safe Operating Area

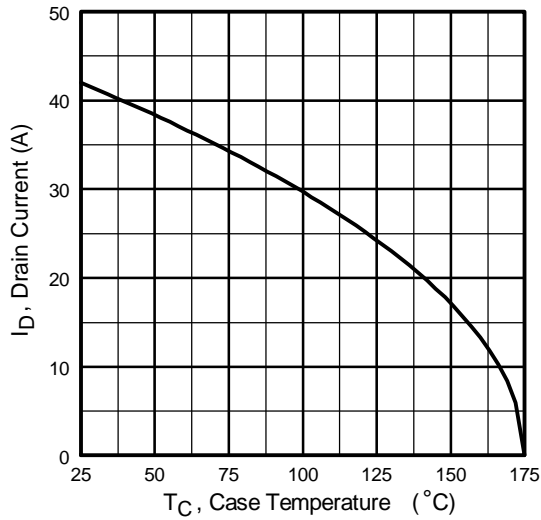

**Fig 9.** Maximum Drain Current Vs. Case Temperature

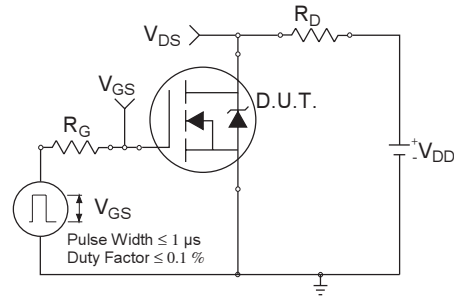

**Fig 10a.** Switching Time Test Circuit



**Fig 10b.** Switching Time Waveforms

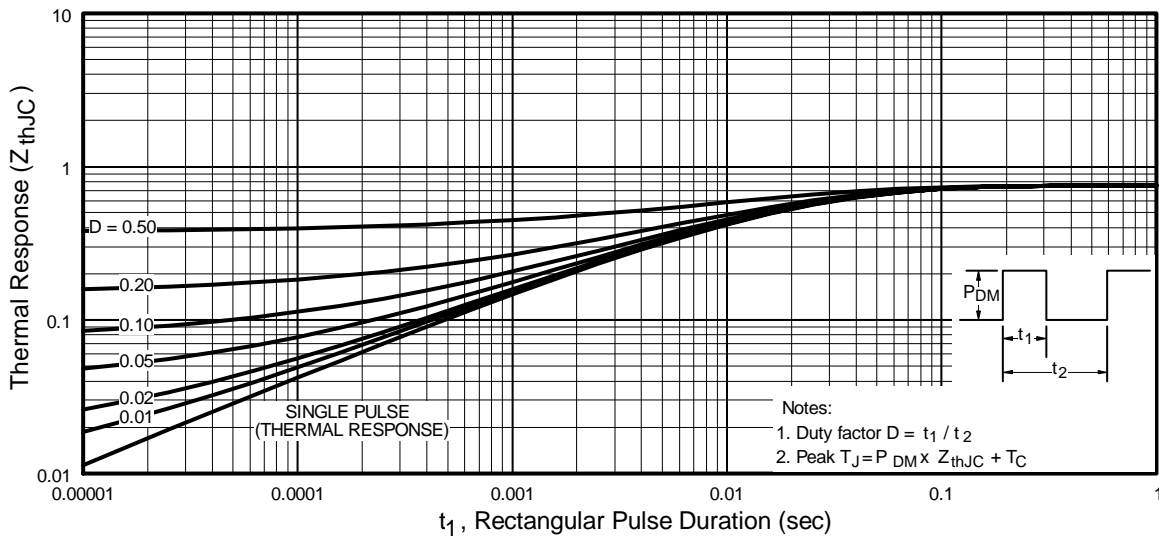

**Fig 11.** Maximum Effective Transient Thermal Impedance, Junction-to-Case

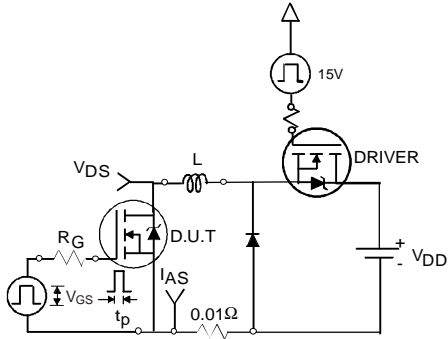

**Fig 12a.** Unclamped Inductive Test Circuit

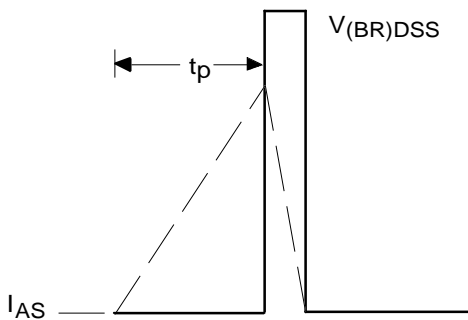

**Fig 12b.** Unclamped Inductive Waveforms

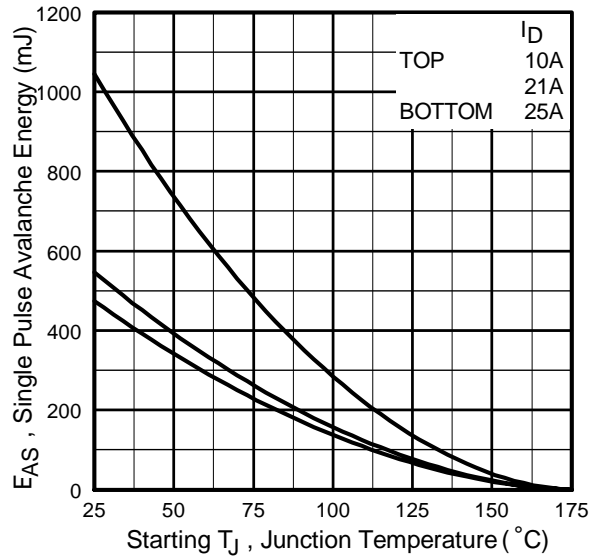

**Fig 12c.** Maximum Avalanche Energy Vs. Drain Current

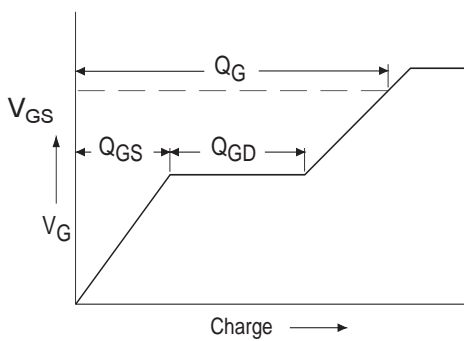
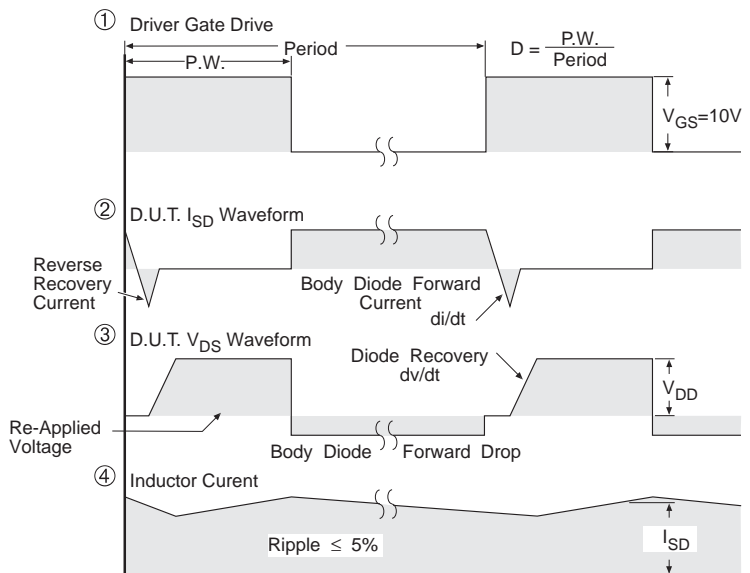

**Fig 13a.** Basic Gate Charge Waveform



**Fig 13b.** Gate Charge Test Circuit

## Peak Diode Recovery dv/dt Test Circuit



\*  $V_{GS} = 5V$  for Logic Level Devices

**Fig 14.** For N-Channel HEXFET® Power MOSFETs

# IRFB/IRFIB/IRFS/IRFSL41N15DPbF

International  
**IR** Rectifier

## TO-220AB Package Outline

Dimensions are shown in millimeters (inches)

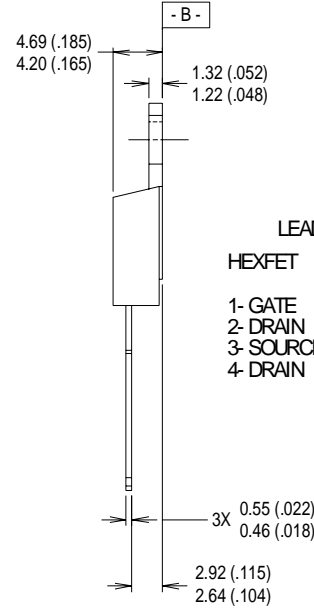
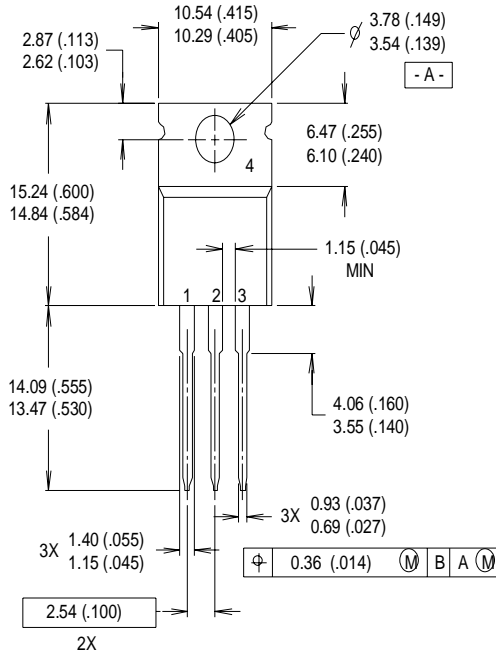

LEAD ASSIGNMENTS

HEXFET	IGBTs, CoPACK
1- GATE	1- GATE
2- DRAIN	2- COLLECTOR
3- SOURCE	3- EMITTER
4- DRAIN	4- COLLECTOR

NOTES:

- 1 DIMENSIONING & TOLERANCING PER ANSI Y14.5M, 1982.
- 2 CONTROLLING DIMENSION : INCH
- 3 OUTLINE CONFORMS TO JEDEC OUTLINE TO-220AB.
- 4 HEATSINK & LEAD MEASUREMENTS DO NOT INCLUDE BURRS.

## TO-220AB Part Marking Information

EXAMPLE: THIS IS AN IRF1010  
 LOT CODE 1789  
 ASSEMBLED ON WW 19, 1997  
 IN THE ASSEMBLY LINE "C"  
**Note:** "P" in assembly line  
 position indicates "Lead-Free"

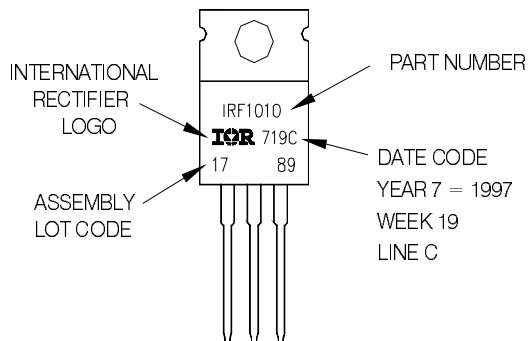



## TO-220 Full-Pak Package Outline

Dimensions are shown in millimeters (inches)

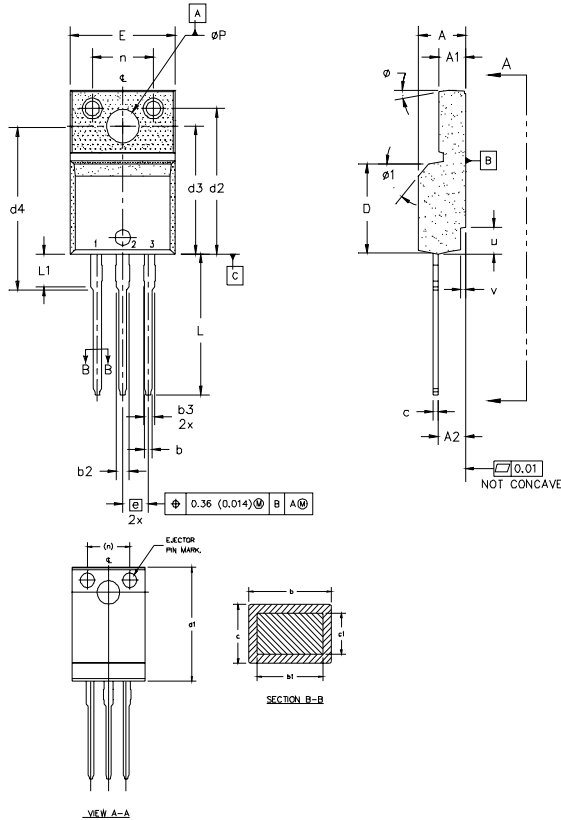

- NOTES:
- 1.0 DIMENSIONING AND TOLERANCING PER ASME Y14.5 M- 1994.
  - 2.0 DIMENSIONS ARE SHOWN IN MILLIMETERS [INCHES].
  - 3.0 LEAD DIMENSION AND FINISH UNCONTROLLED IN L1.
  - 4.0 DIMENSION D & E DO NOT INCLUDE MOLD FLASH. MOLD FLASH SHALL NOT EXCEED 0.005" (0.127) PER SIDE. THESE DIMENSIONS ARE MEASURED AT THE OUTERMOST EXTREMES OF THE PLASTIC BODY.
  - 5.0 DIMENSION b1 APPLY TO BASE METAL ONLY.
  - 6.0 STEP OPTIONAL ON PLASTIC BODY DEFINED BY DIMENSIONS u & v.
  - 7.0 CONTROLLING DIMENSION : INCHES.

SYMBOL	DIMENSIONS				NOTES	LEAD ASSIGNMENTS
	MILLIMETERS		INCHES			
	MIN.	MAX.	MIN.	MAX.		
A	4.57	4.83	0.180	0.190		
A1	2.57	2.83	0.101	0.114		
A2	2.51	2.85	0.099	0.112		
b	0.622	0.89	0.024	0.035		1 - GATE 2 - DRAIN 3 - SOURCE
b1	0.622	0.838	0.024	0.033	5	
b2	1.229	1.400	0.048	0.055		
b3	1.229	1.400	0.048	0.055		
c	0.440	0.629	0.017	0.025		
c1	0.440	0.584	0.017	0.023		
D	8.65	9.80	0.341	0.386	4	
d1	15.80	16.12	0.622	0.635		1 - GATE 2 - COLLECTOR 3 - EMITTER
d2	13.97	14.22	0.550	0.560		
d3	12.30	12.82	0.484	0.509		
d4	8.64	9.91	0.340	0.390		
E	10.36	10.63	0.408	0.419	4	
e	2.54 BSC		0.100 BSC			
L	13.20	13.73	0.520	0.541		
L1	3.10	3.50	0.122	0.138	3	
n	6.05	6.15	0.238	0.242		
phi P	3.05	3.45	0.120	0.136		
u	2.40	2.50	0.094	0.098	6	
v	0.40	0.50	0.016	0.020	6	
phi 1	5"	7"	5"	7"		
phi 7		45"		45"		

## TO-220 Full-Pak Part Marking Information

EXAMPLE: THIS IS AN IRF1840G  
WITH ASSEMBLY  
LOT CODE 3432  
ASSEMBLED ON WW 24 1999  
IN THE ASSEMBLY LINE "K"

**Note:** "P" in assembly line position indicates "Lead-Free"

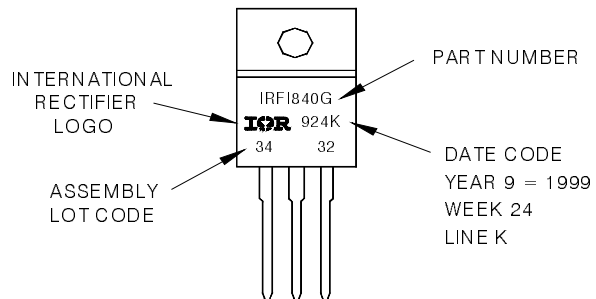

# IRFB/IRFIB/IRFS/IRFSL41N15DPbF

International  
**IR** Rectifier

## D<sup>2</sup>Pak Package Outline

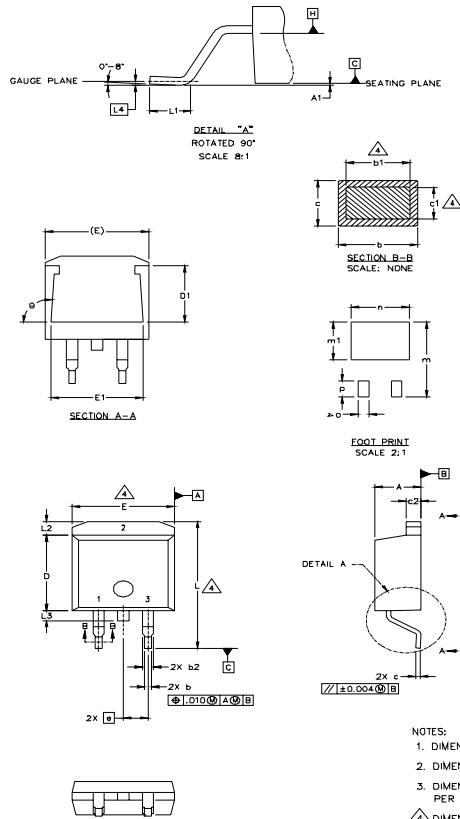

SYMBOL	DIMENSIONS				NOTES
	MILLIMETERS		INCHES		
	MIN.	MAX.	MIN.	MAX.	
A	4.06	4.83	.160	.190	4
A1		0.127		.005	
b	0.51	0.99	.020	.039	
b1	0.51	0.89	.020	.035	
b2	1.14	1.40	.045	.055	4
c	0.43	0.63	.017	.025	
c1	0.38	0.74	.015	.029	
c2	1.14	1.40	.045	.055	3
D	8.51	9.65	.335	.380	
D1	5.33		.210		3
E	9.65	10.67	.380	.420	
E1	6.22		.245		
e	2.54 BSC		.100 BSC		
L	14.61	15.88	.575	.625	
L1	1.78	2.79	.070	.110	
L2		1.65		.065	
L3	1.27	1.78	.050	.070	
L4	0.25 BSC		.010 BSC		
m	17.78		.700		
m1	8.89		.350		
n	11.43		.450		
o	2.08		.082		
p	3.81		.150		
θ	90°	93°	90°	93°	

### LEAD ASSIGNMENTS

HEXFET	IGBTs, CoPACK	DIODES
1.- GATE	1.- GATE	1.- ANODE *
2.- DRAIN	2.- COLLECTOR	2.- CATHODE
3.- SOURCE	3.- EMITTER	3.- ANODE

\* PART DEPENDENT.

### NOTES:

1. DIMENSIONING AND TOLERANCING PER ASME Y14.5M-1994
2. DIMENSIONS ARE SHOWN IN MILLIMETERS [INCHES]
3. DIMENSION D & E DO NOT INCLUDE MOLD FLASH. MOLD FLASH SHALL NOT EXCEED 0.127 [0.005"] PER SIDE. THESE DIMENSIONS ARE MEASURED AT THE OUTMOST EXTREMES OF THE PLASTIC BODY.
4. DIMENSION b1 AND c1 APPLY TO BASE METAL ONLY.
5. CONTROLLING DIMENSION: INCH.

## D<sup>2</sup>Pak Part Marking Information (Lead-Free)

EXAMPLE: THIS IS AN IRF530S WITH  
LOT CODE 8024  
ASSEMBLED ON WW 02, 2000  
IN THE ASSEMBLY LINE 'L'

Note: 'P' in assembly line  
position indicates 'Lead-Free'

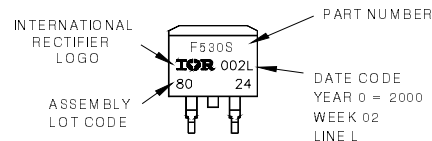

**OR**

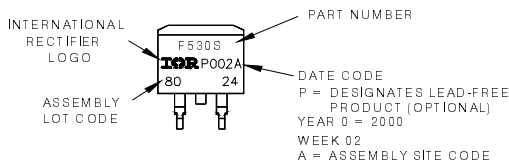

## TO-262 Package Outline

Dimensions are shown in millimeters (inches)

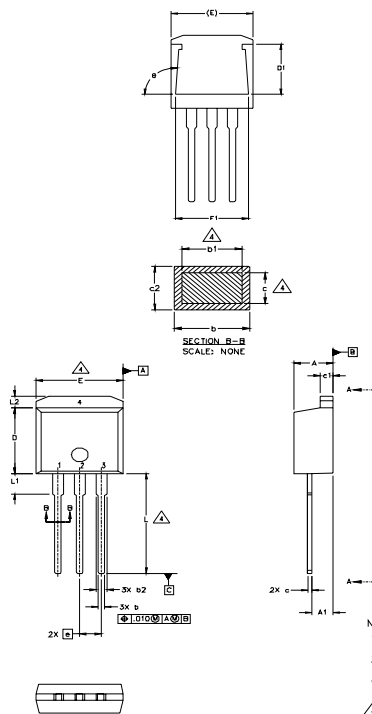

SYMBOL	DIMENSIONS				NOTES
	MILLIMETERS		INCHES		
	MIN.	MAX.	MIN.	MAX.	
A	4.06	4.83	.160	.190	
A1	2.03	2.92	.080	.115	
b	0.51	0.99	.020	.039	
b1	0.51	0.89	.020	.035	4
b2	1.14	1.40	.045	.055	
c	0.38	0.63	.015	.025	4
c1	1.14	1.40	.045	.055	
c2	0.43	.063	.017	.029	
D	8.51	9.65	.335	.380	3
D1	5.33		.210		
E	9.65	10.67	.380	.420	3
E1	6.22		.245		
e	2.54	BSC	.100	BSC	
L	13.46	14.09	.530	.555	
L1	3.56	3.71	.140	.146	
L2		1.65		.065	

### LEAD ASSIGNMENTS

HEXFET	IGBT
1.- GATE	1 - GATE
2.- DRAIN	2 - COLLECTOR
3.- SOURCE	3 - EMITTER
4.- DRAIN	

- NOTES:
1. DIMENSIONING AND TOLERANCING PER ASME Y14.5M-1994
  2. DIMENSIONS ARE SHOWN IN MILLIMETERS [INCHES]
  3. DIMENSION D & E DO NOT INCLUDE MOLD FLASH. MOLD FLASH SHALL NOT EXCEED 0.127 [0.005"] PER SIDE. THESE DIMENSIONS ARE MEASURED AT THE OUTMOST EXTREMES OF THE PLASTIC BODY.
  4. DIMENSION b1 AND c1 APPLY TO BASE METAL ONLY.
  5. CONTROLLING DIMENSION: INCH.

## TO-262 Part Marking Information

EXAMPLE: THIS IS AN IRL3103L  
LOT CODE 1789  
ASSEMBLED ON WW 19, 1997  
IN THE ASSEMBLY LINE 'C'

Note: 'P' in assembly line position indicates 'Lead-Free'

**OR**

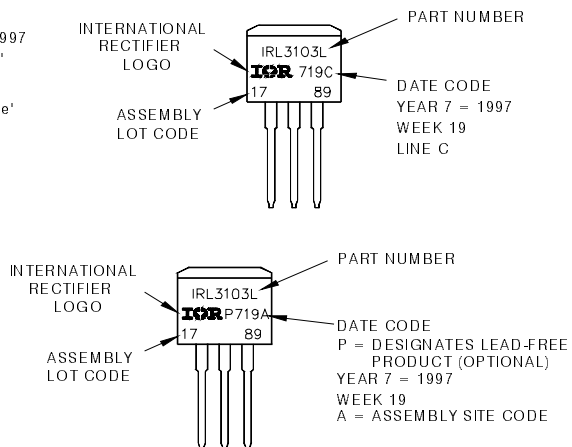

# IRFB/IRFIB/IRFS/IRFSL41N15DPbF

International  
**IR** Rectifier

## D<sup>2</sup>Pak Tape & Reel Information

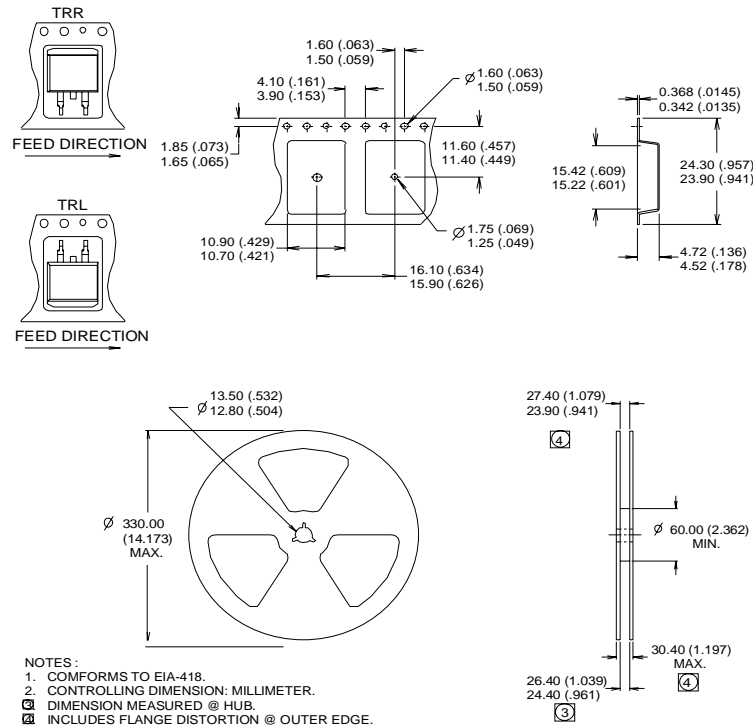

### Notes:

- ① Repetitive rating; pulse width limited by max. junction temperature.
- ② Starting  $T_J = 25^\circ\text{C}$ ,  $L = 1.5\text{mH}$ ,  $R_G = 25\Omega$ ,  $I_{AS} = 25\text{A}$ .
- ③  $I_{SD} \leq 25\text{A}$ ,  $di/dt \leq 340\text{A}/\mu\text{s}$ ,  $V_{DD} \leq V_{(BR)DSS}$ ,  $T_J \leq 175^\circ\text{C}$ .
- ④ Pulse width  $\leq 300\mu\text{s}$ ; duty cycle  $\leq 2\%$ .
- ⑤  $C_{OSS}$  eff. is a fixed capacitance that gives the same charging time as  $C_{OSS}$  while  $V_{DS}$  is rising from 0 to 80%  $V_{DSS}$
- ⑥ This is only applied to TO-220AB package.
- ⑦ This is applied to D<sup>2</sup>Pak, when mounted on 1" square PCB (FR-4 or G-10 Material). For recommended footprint and soldering techniques refer to application note #AN-994.

**TO-220AB & TO-220 FullPak packages are not recommended for Surface Mount Application.**

Data and specifications subject to change without notice.  
This product has been designed and qualified for the Industrial market.  
Qualification Standards can be found on IR's Web site.

International  
**IR** Rectifier

IR WORLD HEADQUARTERS: 233 Kansas St., El Segundo, California 90245, USA Tel: (310) 252-7105  
TAC Fax: (310) 252-7903

Visit us at [www.irf.com](http://www.irf.com) for sales contact information. **08/2006**

[www.irf.com](http://www.irf.com)

Note: For the most current drawings please refer to the IR website at:  
<http://www.irf.com/package/>